

AgieCharmilles

# FORM E

350/600

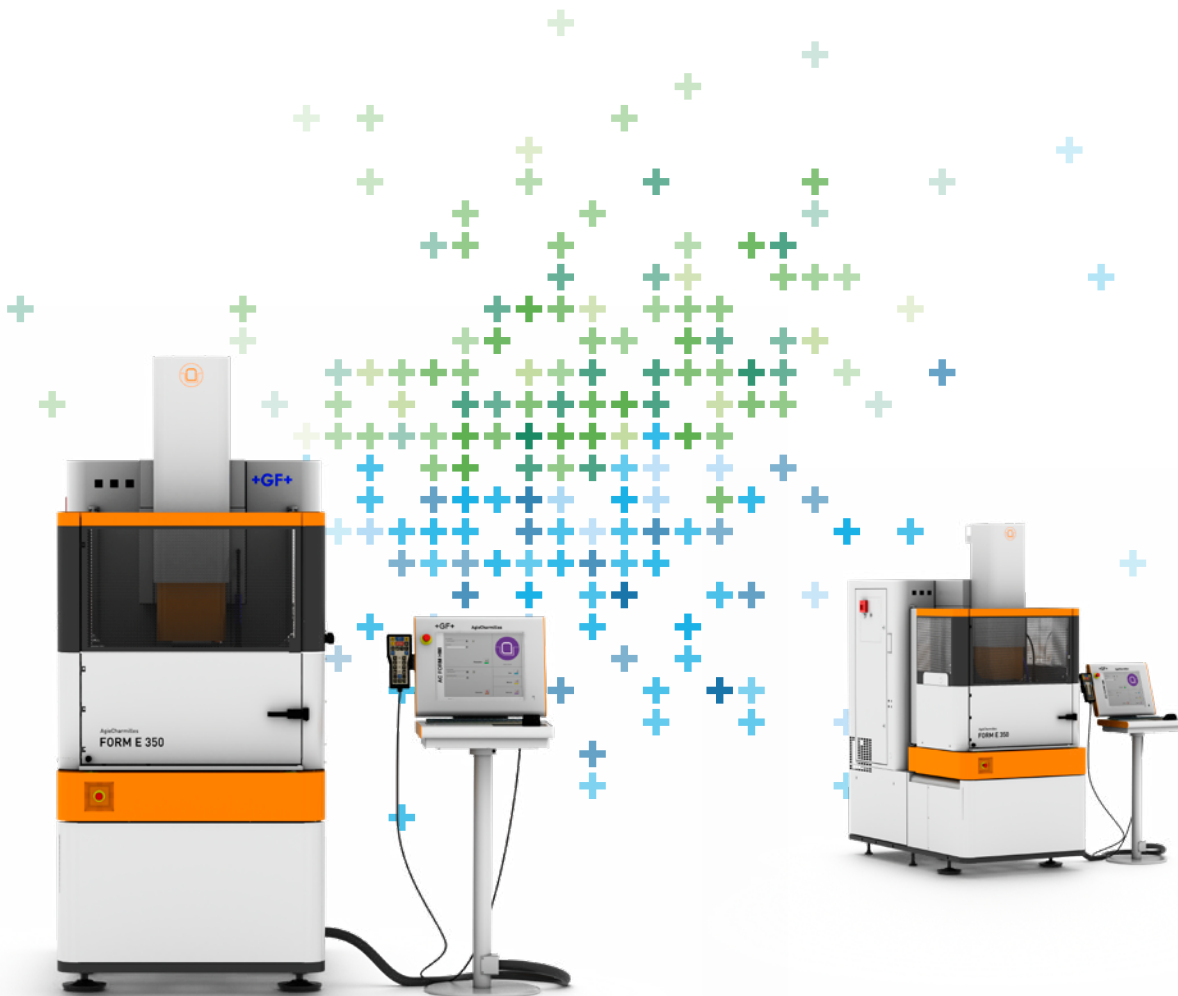

# Passion for Precision

## GF Machining Solutions

When all you need is everything, it's good to know that there is one company that you can count on to deliver complete solutions and services. From unmatched Electrical Discharge Machining (EDM), Laser texturing, Laser micromachining, Additive Manufacturing and first-class Milling and Spindles to Tooling and Automation, all of our solutions are backed by unrivaled Customer Services and expert GF Machining Solutions training. Our AgieCharmilles, Microlution, Mikron Mill, Liechti, Step-Tec and System 3R technologies help you raise your game—and our digital business solutions for intelligent manufacturing, offering embedded expertise and optimized production processes across all industries, increase your competitive edge.



+ We are AgieCharmilles.  
We are GF Machining Solutions.

# Contents

<b>4</b>	<b>Highlights</b>
<b>6</b>	<b>Address every challenge</b>
<b>8</b>	<b>Seal Slot Dedicated Package (optional)</b>
<b>10</b>	<b>Maximize your capabilities per square meter</b>
<b>12</b>	<b>Unattended machining</b>
<b>14</b>	<b>Availability is key for your business</b>
<b>16</b>	<b>Customer Services</b>
<b>18</b>	<b>Technical specifications</b>
<b>22</b>	<b>About GF Machining Solutions</b>

## **Versatile, reliable and easy to use**

The AgieCharmilles FORM E 350/FORM E 600 solutions are amazingly flexible and easy to use, making it possible to cover a wide range of applications. Additionally, they offer exceptional reliability.

## Highlights

# Experience best value for your investment

### Address every challenge

With GF Machining Solutions' die-sinking Intelligent Speed Power Generator (ISPG), you can achieve outstanding performance. The embedded technology allows for solutions that are versatile and can encompass a variety of workpiece and electrode materials to help you grow your business in mold making or part production.

### Boost performance

Boost machining performance in your mold and die applications, thanks to our dedicated packages.

# Everything you need

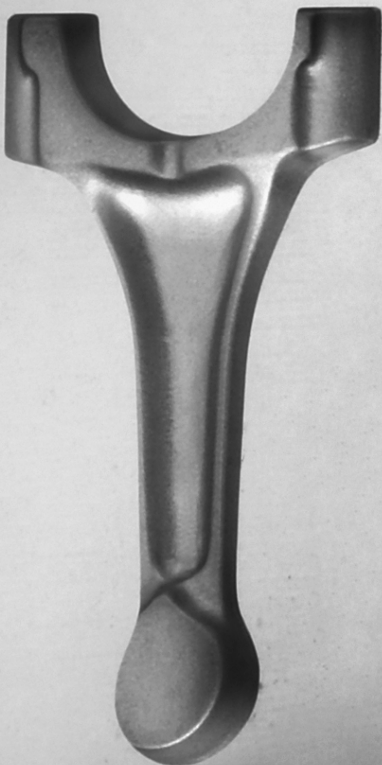

**+ More capability per square meter**  
Get the most favorable floor space to work area ratio with this solution's one-meter width.

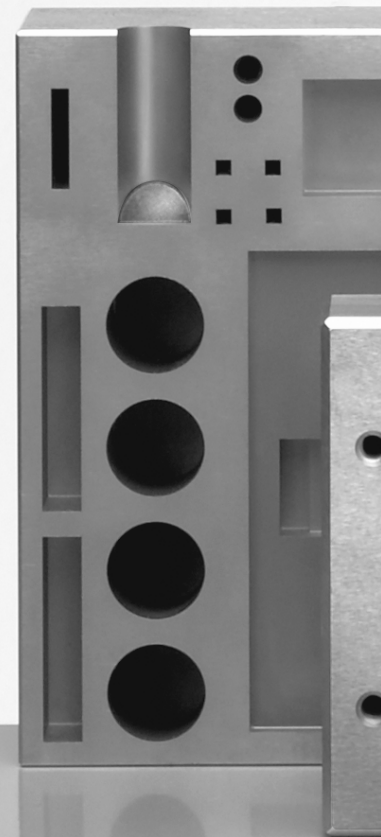

### Maximize your capabilities per square meter

The AgieCharmilles FORM E solutions are the most compact models in the standard level segment. Their space-saving design helps you reduce fixed costs related to loading and machining parts in a small floor space.

### Unattended machining

Reduce your time to market by increasing your flexibility to achieve greater productivity with an external System 3R robot connection.

# thing eed

- + **Generator based on our EDM legacy**  
Every pulse is optimized to reduce your electrode wear by up to 25%.

- + **The ultimate in ergonomics**  
Optimal machining strategies are at your fingertips with our AC FORM Human Machine Interface (HMI).

- + **A versatile solution that tackles any challenge**  
Machine a variety of materials from steel to carbide to increase your business opportunities.

- + **Automatic dielectric**  
Increase your machining time while reducing human intervention.

- + **Higher productivity**  
Optimize your production thanks to the integrated Linear Tool Changer (LTC) or by adding an entry-level System 3R robot.

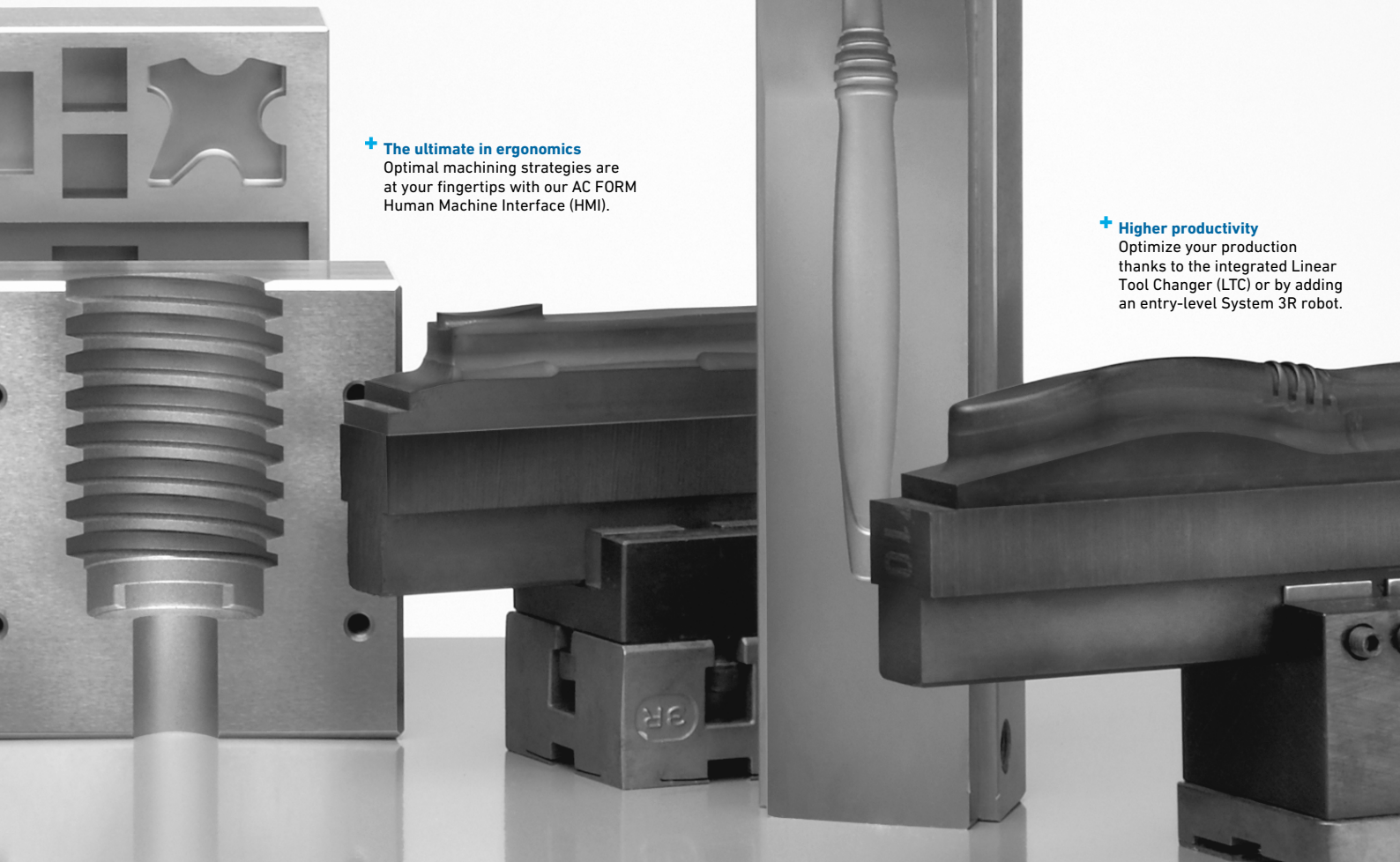

Address every challenge

# Position yourself to outperform competitors

## **Ready for new opportunities, thanks to a versatile solution**

Increase your business opportunities with versatile solutions from GF Machining Solutions. The AgieCharmilles FORM E range can machine a range of materials from steel to carbide, opening new doors for you with its wide variety of technologies.

## **Economic efficiency in serial quality production**

Whatever your electrode material or workpiece to be machined, thanks to wear partitioning, you can save up to 25% on electrode costs. Wear partitioning is an algorithm that is able to share the wear of a tool among a list of cavities to obtain homogeneity of dimensions and aspect. The principle is to split a setting table into packets of one or more settings, and then to apply these packets one after another on each implied cavity. If each cavity is completely machined before moving to the next, the tool will be worn and cannot produce the same geometry when it reaches the final cavity. With a multi-cavity setting, the user has the choice to execute each cavity completely in turn or execute each setting on all the cavities before progressing to the next setting.



Graphite for roughing  
and copper for finishing

Greater flexibility when using  
our mixed-material technology

Graphite  
Fast machining

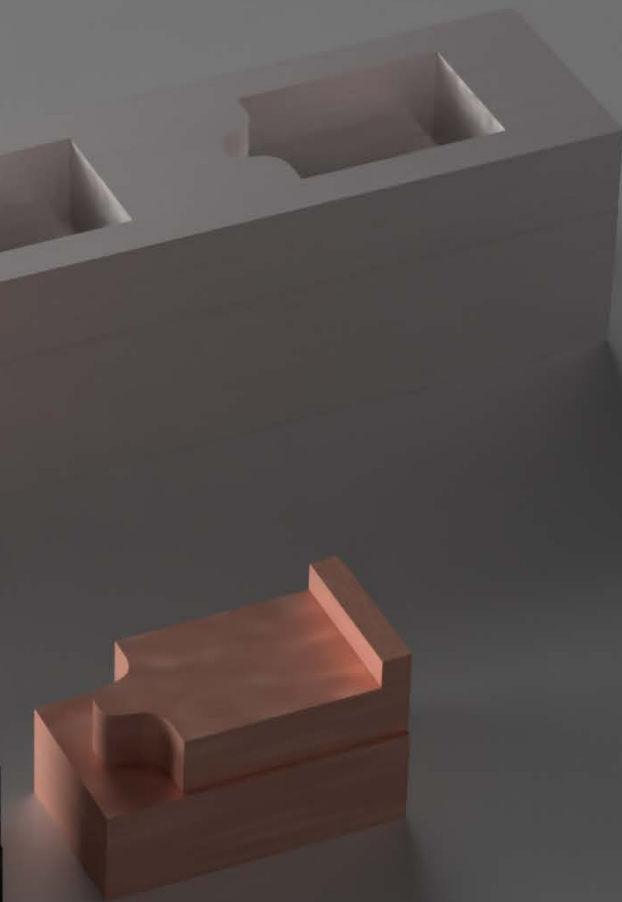

**Copper**

Higher surface finish

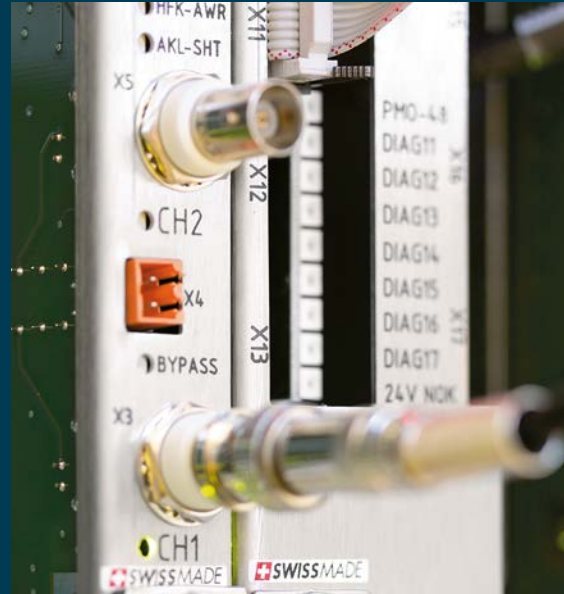

**Intelligent Speed Power Generator based on our EDM legacy**

With this solution's high-end generator, the EDM (Electrical Discharge Machining) process is continuously optimized with every pulse, reducing electrode wear on even the finest finishes. Process control takes a fraction of a second and produces an extremely homogeneous surface finish.

The high-power generator has maximum output of 80 A on the FORM E 350 and 140 A on the FORM E 600. The generator's switchgear cabinet is equipped with a closed water-air cooling circuit that is controlled by the cooling unit within the system. To ensure the longest lifespan and reliability of the electronics, they are contained within a dustproof cabinet, in which the temperature is monitored and stabilized.

Seal Slot Dedicated Package (optional)

# Highly productive machining of seal slots on nozzle guide vanes, shrouds and blades

## Your benefits

- Immediate access to best-in-class process parameters
- Guaranteed stable quality
- Optimized cost for graphite electrodes

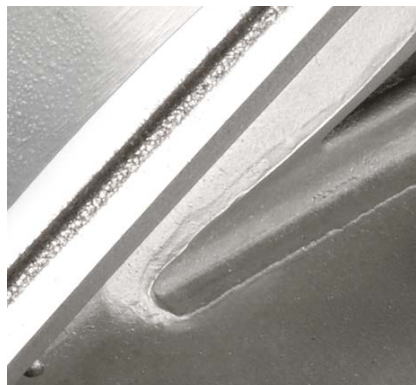
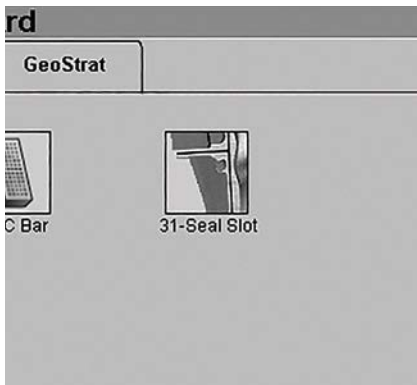

## One-touch optimization

Reap the benefits of our accumulated experience included in the technology for automatic optimization.

## Live process monitoring

Ensure stable part quality and complete traceability with live process tracking and recording of key parameters via the eTracking software.

## AC-K electrode graphite

Developed in-house, AC-K 700 graphite provides the best price-performance ratio for seal slot manufacturing.





Maximize your capabilities per square meter

# Most favorable floor space to work surface area ratio

Profit from the most versatile and compact die-sinking machine on the market. With a width of only one meter for the AgieCharmilles FORM E 350 and 1.6 meters for the AgieCharmilles FORM E 600, you can optimize your production with the Linear Tool Changer.



## Linear Tool Changer (optional)

Designed to be both economical and efficient, the fully integrated Linear Tool Changer (LTC) is ideal for less complex applications requiring few electrodes or involving longer cuts.

FORM E 350: four positions

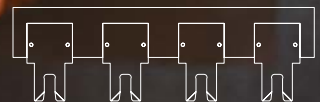

FORM E 600: six positions

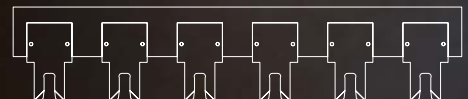

### Solid structure for a reliable, stable operation

Take your productivity to the next level of efficiency with this solution's static, dynamic and rigid mechanical structure. Positioning measurements are made by the means of linear glass scales fixed directly on the X, Y and Z axes to eliminate errors.

### The ultimate in ergonomics

Optimal machining strategies are at your fingertips with our AC FORM HMI, which offers versatile choices for each application. The machine's intelligence and incorporated database takes care of the specific process requirements, relieving the operator from this burden.

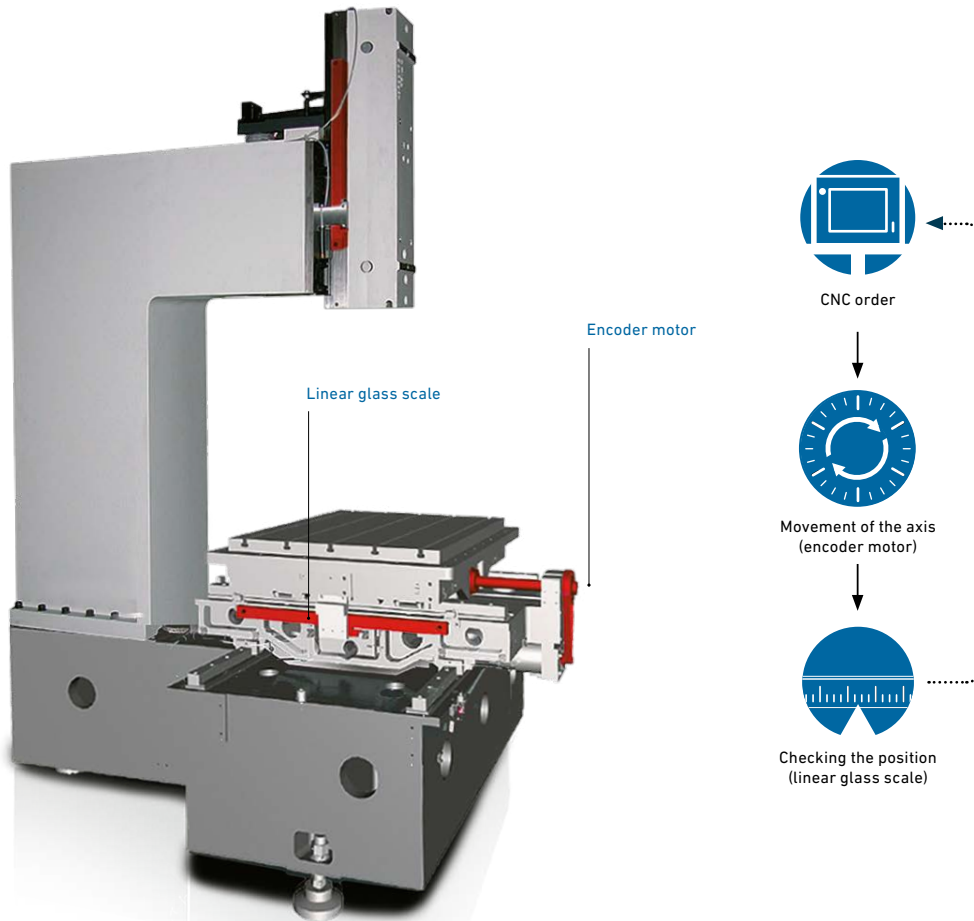

### Closed-loop control

Linear glass scales fixed directly on the X, Y and Z axes of the FORM E 350 and FORM E 600 help ensure precise positioning measurements and eliminate errors that might otherwise arise when the screw thread becomes worn or too hot. Moreover, prior to delivery, every FORM E 350 and FORM E 600 is verified by means of a laser interferometer to guarantee the best possible accuracy.

### C axis

A rugged C axis delivers high positioning precision ( $0.001^\circ$ ) regardless of electrode weight (up to 25 kg) and full machine current. Fully integrated and CNC controlled, the C axis can be easily extended to increase X and Y travels when machining very large parts. Moreover, thanks to the integration of the C axis into the quill of the Z axis, the FORM E 350 and FORM E 600 are incredibly flexible machines, with four axes that can be interpolated simultaneously. This allows an easy machining of curved recesses and undercuts by rotating the C axis and widening the 3D vector.

Unattended machining

# Modularly adapted to your needs

Experience always shows that measures to reduce the idle times of your machines are significantly more worthwhile than chasing seconds in the actual machining process. The solution is a stable and exact System 3R reference system. This lets you preset away from the machine and then set up the machine with minimum idle time, quickly and precisely.

## Boost your competitiveness

Automation keeps production going whatever the time of day or day of the week. Your results are shorter lead times, higher productivity and faster payback of capital invested in your machines. With automated operations, production can continue running around the clock, seven days a week. The possibilities are endless.



Tooling

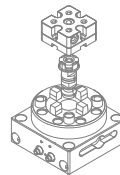

Macro

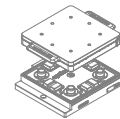

Dynafix

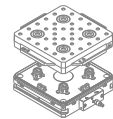

GPS 240



**Increasing your unattended running time**

Experience the benefits of programmable dielectric height for flexible Automation. The AgieCharmilles FORM E 350 was conceived to be as compact as possible in order to save floor space and increase your operators' safety. Achieve higher unattended running time with a solution that eliminates intermediate setup and simplifies any manual intervention thanks to its design.

**Adapted to your success**

System 3R's WorkPartner 1+ (WPT1+) offers maximum magazine capacity while requiring minimum floor space (1290 x 2460 x 2460 mm)\*. Our modular magazines enable an unprecedented flexibility that can be adapted to each user's needs. With generous magazine doors that facilitate loading and unloading, the WPT1+ is extremely user friendly. Further advantages include rapid change cycles and integrated pneumatic control of gripping devices and table chucks.

\* Width x depth x height

**Front view**



Two doors, access to all shelves for loading

Security glass door, 10 mm

**Rear view**



Loading door with sliding shelf that can function as a loading station

**Entry level**



Seven levels of Macro electrodes

42 positions in total

**WPT1+ entry level**



Three magazine positions

Loading station (can also be used as a magazine position)

Draining station (can also be used as a magazine position)

The magazine's capacity is determined by the shape and size of the workpieces.

Availability is key for your business

# Connecting you to the future

The time you spend machining is time you are making money.  
That's why we focus on optimizing your productivity and machine availability.

## Secure highest availability with rConnect

rConnect comprises our modular digital services. From Live Remote Assistance (LRA) ensuring maximum machine uptime via process improvement modules to predictive maintenance and monitoring, rConnect keeps you connected anytime, wherever you are.

Closer support for you



rConnect

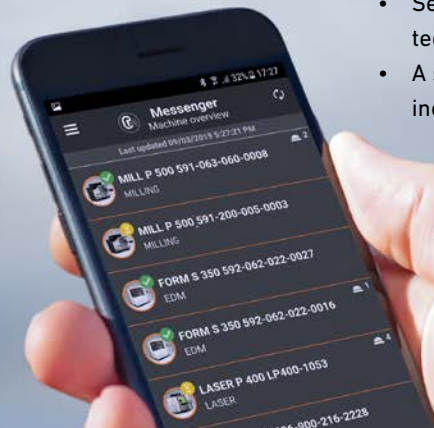

## Your benefits with rConnect

- Detailed information about your machine with one cockpit per machine
- Increased machine uptime
- Direct interactive access to our service specialists
- Faster identification of potential problems
- Secure connection based on the latest technology—certified by TÜVIT
- A significant step toward smart services to increase your efficiency

# Econowatt smart module: Take action to save energy

For several years, the cost of energy has been increasing steadily. For this reason, controlling production costs and saving energy have become priorities for nearly all workshops. With its Econowatt smart module, GF Machining Solutions supports you in saving energy and reducing your impact on the environment.

## Increase your competitiveness

- An automatic “wake up” can be programmed into a weekly calendar
- Prior to the scheduled time for restarting work, the machine automatically restarts to enable thermostabilization of the dielectric.
- As a result, each morning, the equipment is prepared and ready to carry out the requested tasks.





With the Econowatt smart module, you can save, per machine, enough energy to run two houses for a year.

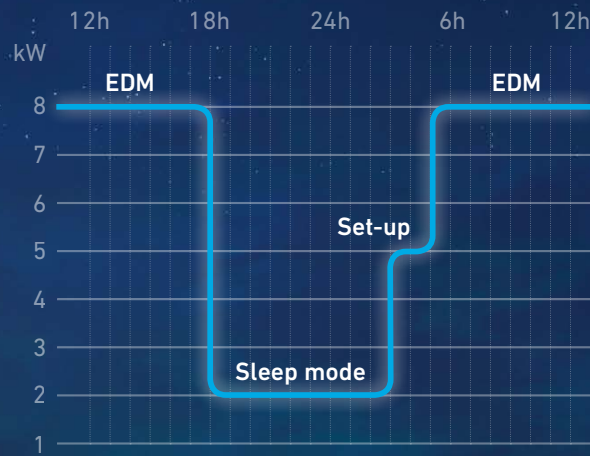

Customer Services

# Accelerate your production to new levels of success

Experience the highest performance of your equipment with GF Machining Solutions Customer Services providing you with unbeatable life cycle support.

## **Keep pace in a changing environment**

As your business evolves, so does its needs, and you can count on GF Machining Solutions for the individually tailored solutions to enhance your operational excellence. We help you keep pace with the continuously changing business and market environments and outperform your competitors.



### **Operations Support: solutions to boost your applications**

Your single source provider of a vast selection of certified consumables including electrodes and filters to achieve optimum level of performance.

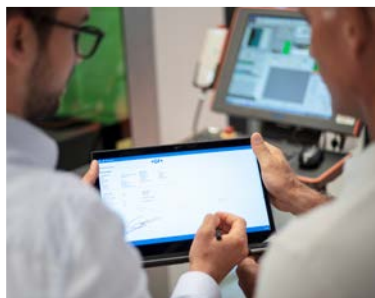

### **Machine support: securing your sustainable machining success**

Preventive maintenance as well as advanced preventive services such as circularity tests with ball bar or laser calibration will optimize your uptime.



### **Business support: realize the full potential of your equipment**

Advanced support and consulting—including training, upgrades and dedicated Automation solutions—to improve your performance, productivity and competitive edge.



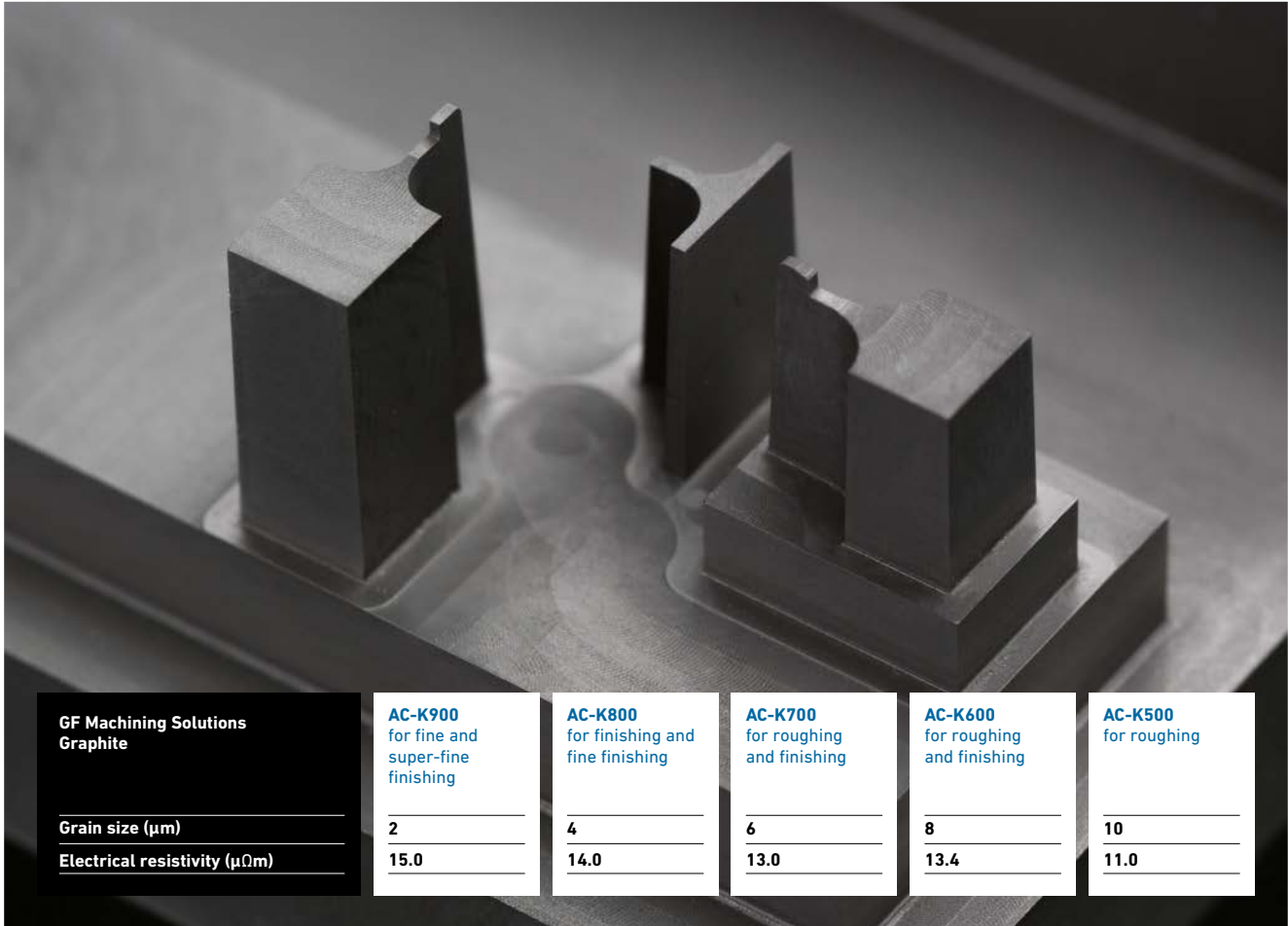

## EDM graphite

# Increase your productivity, optimize your costs and time

GF Machining Solutions offers various grades of graphite with a wide range of performance characteristics. Each grade can be dedicated to a specific range of applications.

### Easy and quick machining, no deburring

Excellent machinability result in high cutting speed rate and time savings in electrode production. In contrast to copper electrodes, graphite electrodes require no additional deburring operation.

### Higher removal rate and high resistance to wear compared to copper

Optimal erosion time and minimal electrode wear results in both cost and time savings.

### High thermal stability and high resistant to thermal shock

Electrode dimensions remain stable during the erosion process and high current densities are maintained. Graphite's light weight makes it easier to manage and handle large electrodes and optimize electrode costs.

### Saw-cut service

- We can cut your graphite block to the size you need and in the grade that best fits your application.
- Contact your local partner to discuss your desired dimensions and graphite grade.

# Technical specifications



FORM E 350



FORM E 350

		FORM E 350	FORM E 600
<b>Machine</b>			
Architecture		Stabilized cast iron cross table	Stabilized cast iron cross table
Dimensions (*)	mm (in)	1000 x 1731 x 2372 (39.37 x 68.15 x 93.39)	1600 x 2700 x 2858 (62.99 x 106.30 x 112.52)
Total weight (without dielectric)	kg (lbs)	1730 (3748)	4400 (9700)
Floor space (**)	mm (in)	1420 x 1731 (55.91 x 68.15)	2020 x 2700 (79.53 x 106.30)
<b>X, Y, Z axes</b>			
X, Y, Z travel (*)	mm (in)	350 x 250 x 250 (13.78 x 9.85 x 9.85)	600 x 400 x 400 (23.63 x 15.75 x 15.75)
X, Y, axes speed	m/min (ft/min)	4 (13.12)	4 (13.12)
Z axis speed	m/min (ft/min)	6 (19.69)	6 (19.69)
Positioning resolution X, Y, Z	µm (µin)	0.1 (4)	0.1 (4)
<b>Work area</b>			
Work tank size (*)	mm (in)	955 x 540 x 350 (37.60 x 21.26 x 13.78)	1200 x 800 x 500 (47.25 x 31.50 x 19.69)
Work table size (**)	mm (in)	630 x 400 (24.81 x 15.75)	800 x 600 (31.50 x 23.63)
Distance floor to clamping level	mm (in)	900 (35.43)	900 (35.43)
Min./max. distance between table and chuck	mm (in)	170/420 (6.69/16.53)	190/590 (7.48/23.23)
<b>Workpiece and electrode</b>			
Max. electrode weight	kg (lbs)	50 (110)	100 (220)
Max. workpiece weight	kg (lbs)	200 (440)	1000 (2204)
Max. workpiece dimensions (*)	mm (in)	800 x 500 x 265 (31.50 x 19.69 x 10.44)	1000 x 700 x 400 (39.37 x 27.56 x 15.75)
Bath level	mm (in)	140 – 310 (5.52 – 12.21)	150 – 450 (5.91 x 17.72)
<b>Dielectric unit</b>			
Capacity	l (gal)	270 (71.33)	750 (200)
Number of filter elements and type		2 paper cartridges H 15 (3-5 µ)	6 paper cartridges H 15 (3-5 µ)
<b>Generator</b>			
Generator type		ISPG	ISPG
Max. machining current (option)	A	80	140
Best surface finish	µm Ra (µin)	0.1 (4)	0.1 (4)

\* Width x depth x height \*\* Width x depth



**FORM E 600**



**FORM E 600**

		FORM E 350	FORM E 600
<b>Electrical supply</b>			
Standard voltage		3 x 380 V/400 V ±10%, 50/60 Hz (50 Hz standard)	
<b>Control Unit</b>			
Operating system		Windows	
Data input		17" LCD screen, mouse or touch screen, keyboard and remote control	
User interface		AC FORM HMI	
Expert systems		TECFORM	
<b>Modules</b>			
Linear Tool Changer (***)		Up to 4 positions	Up to 6 positions
GammaTEC		Option	Option
iQ graphite and copper module for reduction of electrode wear		Standard	Standard
<b>Standard C axis</b>			
Max. electrode weight on automatic chuck	kg (lbs)	25 (55)	25 (55)
Rotation speed	rpm	0-100	0-100
Max. inertia	kgcm <sup>2</sup> (lbsin <sup>2</sup> )	2000 (683)	2000 (683)

\*\*\* Option

**FORM E 350**

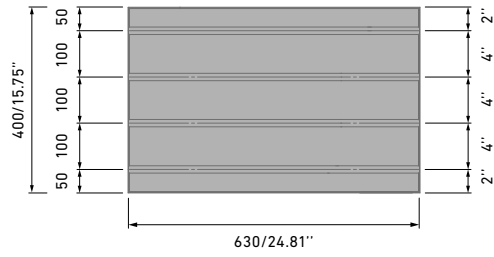
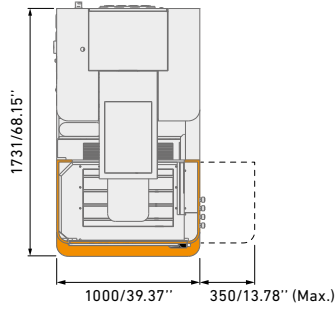
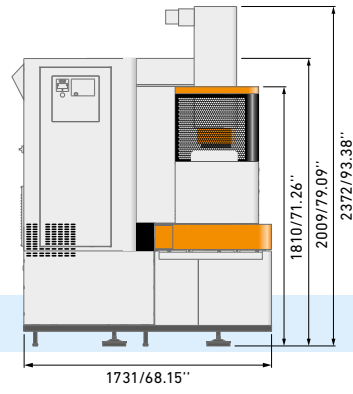
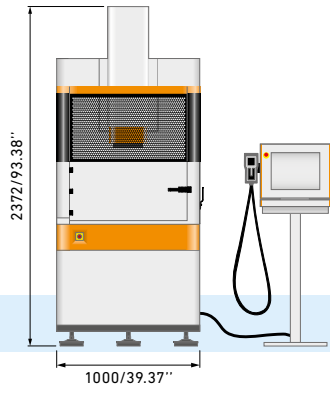

**FORM E 600**

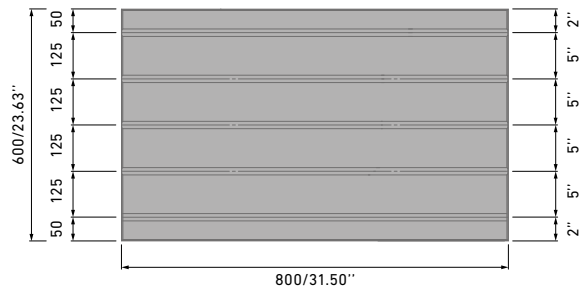
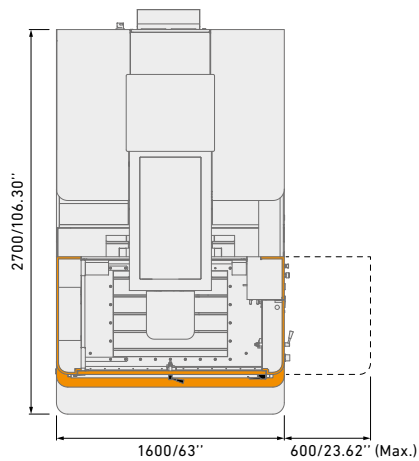
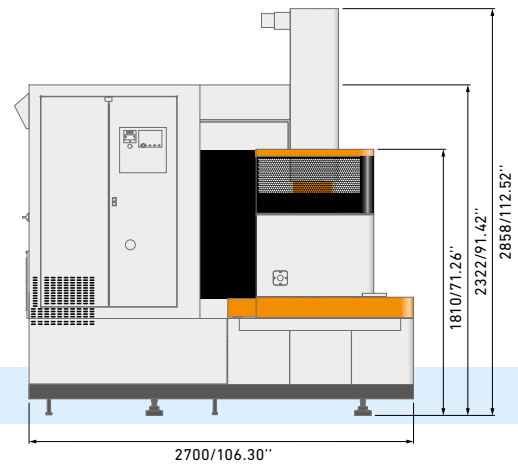
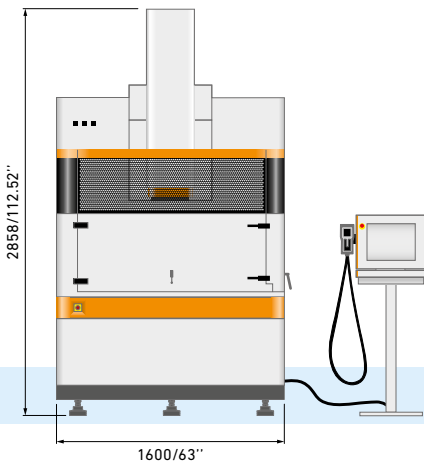



## About GF Machining Solutions

# Multi-technology solutions provider

Our commitment to you and your specific applications is proven by the value-adding intelligence, productivity and quality delivered by our multi-technology solutions. Your success is our chief motivator. That's why we are continuously advancing our legendary technical expertise. Wherever you are, whatever your market segment and whatever the size of your operation, we have the complete solutions and the customer-centric commitment to accelerate your success—today.

### EDM (Electrical Discharge Machining)



#### Wire-cutting EDM

GF Machining Solutions' wire-cutting EDM is fast, precise and increasingly energy efficient. From ultraprecise machining of miniaturized components down to 0.02 mm to powerful solutions for demanding high-speed machining with respect to surface accuracy, our wire EDM solutions position you for success.

#### Die-sinking EDM

GF Machining Solutions is revolutionizing die-sinking EDM with features like iGAP technology to dramatically boost machining speed and reduce electrode wear. All of our die-sinking systems offer fast removal and deliver mirror finishes of Ra 0.1 µm (4 µin).

#### Hole-drilling EDM

GF Machining Solutions' robust hole-drilling EDM solutions enable you to drill holes in electrically conductive materials at a very high speed—and, with a five-axis configuration, at any angle on a workpiece with an inclined surface.

### Milling



#### Milling

Precision tool and mold manufacturers enjoy a competitive edge with our Mikron MILL S solutions' fast and precise machining. The Mikron MILL P machines achieve above-average productivity thanks to their high performance and Automation. Customers seeking fastest return on investment benefit from the affordable efficiency of our MILL E solutions.

#### High Performance Airfoil Machining

Our Liechti turnkey solutions enable the highly dynamic manufacturing of precision airfoils. Thanks to the unique performance and our expertise in airfoil machining, you increase productivity by producing at the lowest cost per part.

#### Spindles

As part of GF Machining Solutions, Step-Tec is engaged in the very first stage of each machining center development project. Compact design combined with excellent thermal and geometric repeatability ensure the perfect integration of this core component into the machine tool.

### Advanced manufacturing



#### Laser texturing

Aesthetic and functional texturing is easy and infinitely repeatable with our digitized Laser technology. Even complex 3D geometries, including precision parts, are textured, engraved, microstructured, marked and labeled.

#### Laser micromachining

GF Machining Solutions offers the industry's most complete line of Laser micromachining platforms optimized for small, high-precision features to meet the increasing need for smaller, smarter parts to support today's leading-edge products.

#### Laser Additive Manufacturing (AM)

GF Machining Solutions and 3D Systems, a leading global provider of additive manufacturing solutions and the pioneer of 3D printing, have partnered to introduce new metal 3D printing solutions that enable manufacturers to produce complex metal parts more efficiently.

### Tooling and Automation



#### Tooling

Our customers experience complete autonomy while maintaining extreme accuracy, thanks to our highly accurate System 3R reference systems for holding and positioning electrodes and work pieces. All types of machines can easily be linked, which reduces set-up times and enables a seamless transfer of workpieces between different operations.

#### Automation

Together with System 3R, we also provide scalable and cost-effective Automation solutions for simple, single machine cells or complex, multi-process cells, tailored to your needs.

### Software



#### Digitalization solutions

To drive its digital transformation, GF Machining Solutions acquired symmedia GmbH, a company specialized in software for machine connectivity. Together, we offer a complete range of Industry 4.0 solutions across all industries. The future requires the ability to adapt quickly to continual digital processes. Our intelligent manufacturing offers embedded expertise, optimized production processes, and workshop Automation: solutions for smart and connected machines.

### Customer Services



#### Worldwide for you

Ensuring the best performance throughout the lifetime of our customers' equipment is the goal of our three levels of support. Operations Support offers the complete range of original wear parts and certified consumables. Machine Support includes spare parts, technical support, and a range of preventive services to maximize machine uptime. Business Support offers customer-specific business solutions.



## Switzerland

---

Biel/Bienne  
Losone  
Geneva  
Flawil  
Langnau

[www.gfms.com](http://www.gfms.com)  
[www.gfms.com/ch](http://www.gfms.com/ch)

## Europe

---

Germany, Schorndorf  
[www.gfms.com/de](http://www.gfms.com/de)

United Kingdom, Coventry  
[www.gfms.com/uk](http://www.gfms.com/uk)

Italy, Agrate Brianza - MI  
[www.gfms.com/it](http://www.gfms.com/it)

Spain, Sant Boi de Llobregat  
Barcelona  
[www.gfms.com/es](http://www.gfms.com/es)

France, Palaiseau  
[www.gfms.com/fr](http://www.gfms.com/fr)

Poland, Raszyn / Warsaw  
[www.gfms.com/pl](http://www.gfms.com/pl)

Czech Republic, Brno  
[www.gfms.com/cz](http://www.gfms.com/cz)

Sweden, Vällingby  
[www.gfms.com/system3r](http://www.gfms.com/system3r)

Turkey, Istanbul  
[www.gfms.com/tr](http://www.gfms.com/tr)

## Americas

---

USA  
Lincolnshire, IL  
Chicago, IL  
Holliston, MA  
Huntersville, NC  
Irvine, CA  
Woodridge, IL  
[www.gfms.com/us](http://www.gfms.com/us)

Canada, Mississauga ON  
[www.gfms.com/us](http://www.gfms.com/us)

Mexico, Monterrey NL  
[www.gfms.com/us](http://www.gfms.com/us)

Brazil, São Paulo  
[www.gfms.com/br](http://www.gfms.com/br)

## Asia

---

China  
Beijing, Shanghai,  
Chengdu, Dongguan,  
Hongkong, Changzhou  
[www.gfms.com/cn](http://www.gfms.com/cn)

India, Bangalore  
[www.gfms.com/sg](http://www.gfms.com/sg)

Japan  
Tokyo, Yokohama  
[www.gfms.com/jp](http://www.gfms.com/jp)

Korea, Seoul  
[www.gfms.com/kr](http://www.gfms.com/kr)

Malaysia, Petaling Jaya  
[www.gfms.com/sg](http://www.gfms.com/sg)

Singapore, Singapore  
[www.gfms.com/sg](http://www.gfms.com/sg)

Taiwan  
Taipei, Taichung  
[www.gfms.com/tw](http://www.gfms.com/tw)

Vietnam, Hanoi  
[www.gfms.com/sg](http://www.gfms.com/sg)

## At a glance

We enable our customers to run their businesses efficiently and effectively by offering innovative Milling, EDM, Laser, Additive Manufacturing, Spindle, Tooling and Automation solutions. A comprehensive package of Customer Services completes our proposition.

[www.gfms.com](http://www.gfms.com)

